

Before using the instrument, please read this manual carefully, and save it well for future using.

Catalogue

Declaration	1
Safety declaration.....	1
Safety instructions.....	2
Safety symbols.....	3
Overview	3
Functional features.....	3
Meter introduction	4
Input/output terminals.....	4
Meter panel description.....	4
Show symbol description.....	8
Use of meter	11
L-PE firewire to ground voltage measurement.....	11
L-N firewire to zero voltage measurement.....	11
LOOP measurement.....	11
RCD (earth leakage switch) measurement.....	12
AUTORAMP triggered current measurement.....	13

Measurement data storage.....	13
Reading stored data.....	14
Clear stored data.....	14
Input voltage indication.....	15
Backlight display.....	15
Auto shutdown.....	15
Overheating alert.....	16
Low battery voltage indication.....	16
General properties.....	16
Technical specifications.....	17
RCD Test Current Selection Table.....	18
Battery replacement.....	18

DISCLAIMER

In accordance with international copyright law, no part of this instruction manual may be reproduced in any form (including storage and retrieval or translation into other national or regional languages) without permission and written consent. This manual is subject to change in future editions without notice.

Safety statement

Caution

The "CAUTION" symbol indicates conditions and operations that can cause damage to the instrument or equipment.

It requires that care must be taken when performing this operation and that failure to perform this operation correctly or to follow this procedure may result in damage to the instrument or equipment. Do not proceed with any operation indicated by the CAUTION symbol unless these conditions are met or fully understood

WARNING

The "WARNING" symbol indicates conditions and operations that pose a danger to the user.

It requires that care must be taken when performing this operation and that failure to perform this operation correctly or to follow the procedure may result in personal injury or death. Do not proceed with any operation indicated by the warning sign unless these conditions are met or fully understood.

**Before using the instrument, please read the instructions carefully
and take note of the relevant safety warnings.**

Safety instructions

The instruments are designed in accordance with the safety requirements of the international electrical safety standard IEC61010-1 being for electronic test instruments. The instruments are designed and manufactured in strict compliance with IEC61010-1 being for 600V CAT IV and Pollution Class 2.





 WARNING

In order to avoid possible electric shock or personal injury, the following specifications should be observed in practice:

- Use the instrument strictly in accordance with the instructions in this manual, otherwise the protection provided by the instrument may be damaged
- Do not use the instrument if it or the test leads have been damaged or if the instrument does not operate properly. If in doubt, send the instrument for repair
- Before measuring, use the meter to verify proper operation by measuring a known voltage
- Special care when using the meter to measure beyond 30V AC true RMS, 42V AC peak or 60 volts DC. There is a risk of electric shock at these voltages
- Replace the batteries as soon as possible when the low battery indicator appears
- Do not use the instrument near explosive gases or steam
- Remove the test leads from the instrument before opening the case or battery cover. Never operate the instrument with being disassembled or with the battery cover open.
- When working in hazardous premises, always observe local and national safety regulations.

- When working in hazardous areas, use appropriate protective equipment in accordance with the regulations of the local or national authorities.

Safety symbols

	Important safety signs		Double insulation (Class II safety equipment)
	High voltage danger		Battery level
	Ground		

Overview

Thank you for purchasing a Leakage Switch Tester designed and manufactured by us. In order to make the most of the meter's performance, please read this manual carefully before using and keeping it in an easily accessible place.

This Leakage Switch Tester incorporates the latest technology into a compact, rugged, easy to use and portable instrument that can measure the switch leakage, trip current, trip time, loop resistance and on-line voltage. It is an ideal tool for electricians to do testing, inspection and repair

Functional features

- Jump-off current measurement
- Jump-off time measurement
- Contact voltage measurement
- Loop resistance measurement

- AC phase voltage measurement: 0V - 440V.
- Frequency measurement : AC 45Hz-65Hz
- Test current magnification: 0.5,1,and 5
- Fast/slow current test gears: 10,30,100,300, 500mA
- 1000 sets of test results can be stored
- Data stored in the host computer can be uploaded to a PC via the USB 2.0 interface

Introduction to the instrument

Input/output terminals

AC IN: Test terminals

USB: USB port used to connect the tester to a PC

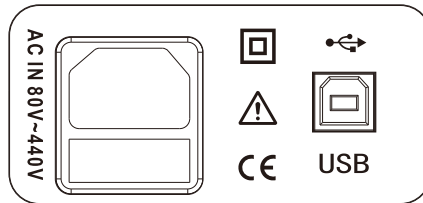

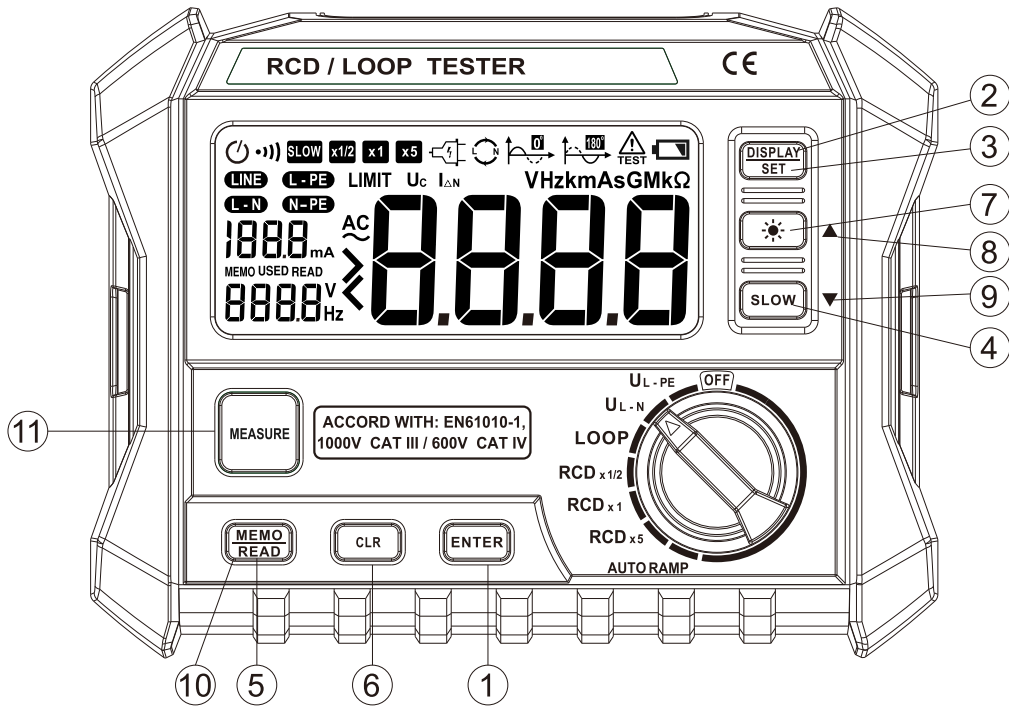

Key Description

① ENTER

After selecting the setting, press the key to confirm

② DISPLAY

Press this key to toggle the split screen display of the measurement data

③ SET

While in the measurement state, the trip current, trigger phase, loop resistance limit voltage can be set by pressing this key, then press ▲ and ▼ to select the range, then press Set to confirm.

④ SLOW

The S measurement mode can be displayed by pressing this key when measuring an RCD with delay.

⑤ READ

In standby mode, the stored data number can be displayed by pressing the key, the stored data can be displayed by pressing the ENTER key and then pressing the key to return.

⑥ CLR

The measurement data stored in the instrument with the specified number can be cleared by pressing this key and then pressing ENTER key when in reading data or in standby mode

⑦ LIGHT

Turn the LCD backlight on or off, the LCD backlight will turn off automatically after 30 seconds, press this KEY to cancel the automatic shutdown function when the power on

⑧ **▲: Forward search key**

When reading a stored file, the stored data can be searched forward and displayed on the display by pressing the ▲ key. Each time the key is pressed, the search moves forward one set of data. When setting the status, select the trigger current step and set the loop resistance limit alarm voltage (25V or 50V).

⑨ **▼ : Backward search key**

When reading a stored file, the stored data can be searched backwards and displayed on the display by pressing the ▼ key. Each time the key is pressed, the search moves backwards one set of data. When setting the status, select the trigger current step, the trigger phase angle and set the loop resistance limit alarm voltage (25V or 50V).

⑩ **MEMO**

After the measurement has stopped, the stored number can be displayed by pressing the key and the held data can be stored in the instrument. The instrument can store up to 1000 sets of data.

⑪ **MEASURE**











Press this key during LOOP, RCD and AUTORAMP measurements to start the measurement, the measurement light will flash during the measurement and will automatically go out when the measurement is finished. (The test cannot be performed if the test lead is not plugged in or if the test lead is disconnected or there is no AC voltage, pressing the measurement key has no effect)

Rotary switch description

Symbols	Gear	Function
OFF	Power off	Turn off the meter
L-PE	Voltage	Measuring the voltage from the fire wire to the earth wire
L-N	Voltage	Measuring the voltage from the fire wire to the zero wire
LOOP	Loop	Measuring the resistance of a loop
×1/2	0.5 magnification	Multiplier for trigger leakage current (Example: $30\text{mA} \times 0.5 = 15\text{mA}$)
×1	1 magnification	Multiplier for trigger leakage current (Example: $30\text{mA} \times 1 = 30\text{mA}$)
×5	5 magnification	Multiplier for trigger leakage current (Example: $30\text{mA} \times 5 = 150\text{mA}$)
AUTORAMP	Automatic current	Automatic trigger current testing

Note: After the instrument is automatically turned off, the knob switch must be turned to the OFF position for 5 seconds before performing the normal operation .

Show symbol description

Indicator	Description	Indicator	Description
	Auto shutdown		AC Symbols
	Fire-wire to zero-wire positive		Test line with high voltage
	Fire-wire to zero-wire reverse		Sockets are connected properly
	Alarm		Negative 180 degree trigger
	Battery level indication		Positive 180 degree trigger
	Nominal trigger current	TEST	Being tested
K	Thousand	S	RCD with time delay
ms	Milliseconds	Uc	Loop voltage
mA	Milliamperes	Hz	Frequency units
Ω	Ohm	L-E	Fire-wire to ground
LIMIT	Exceeds	L-N	Fire-wire to zero
U	Voltage	READ	Read
V	Voltage units	MEMO	Storage
USED	Used		

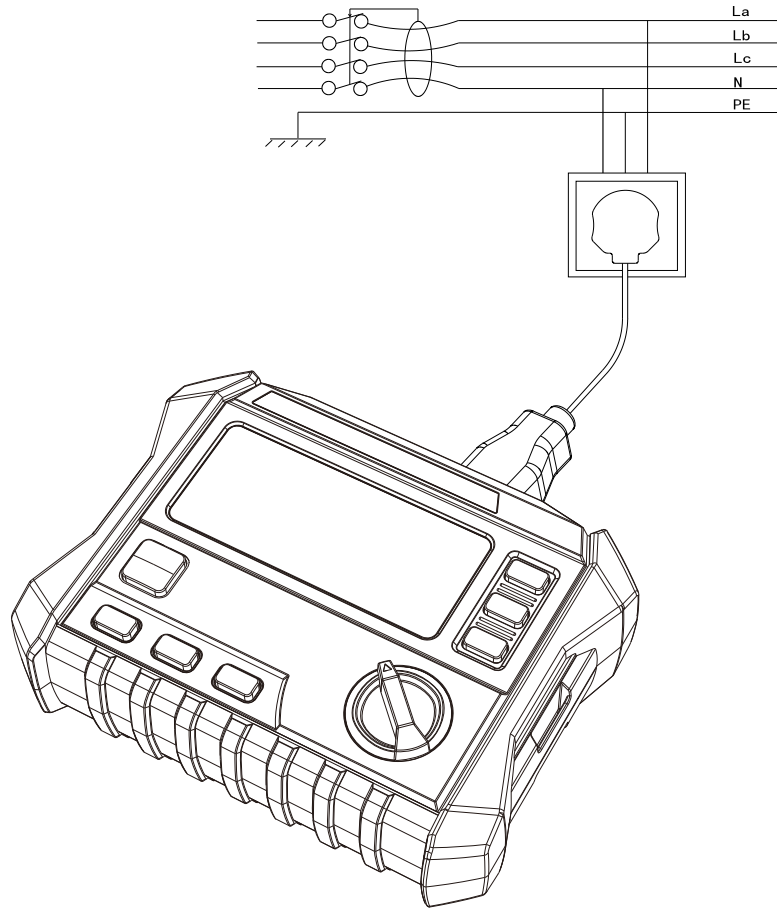

Use of meters

L-PE Fire-wire to ground voltage measurement

1. Place the function change knob in L-PE and connect the test leads with reference to the diagram above.
2. The instrument automatically measures and displays the fire-to-ground voltage and frequency.
3. If you want to store the measurement results, press the **"MEMO/READ"** button to store the test results.

Note: When measuring the L-PE voltage, the Fire (L) and Earth (E) wires must be connected.

L-N Fire-wire to zero voltage measurement

1. Set the function knob to L-N and connect the test leads with reference to the diagram above.
2. The instrument automatically measures and displays the fire-to-zero voltage and frequency.
3. If you want to store the measurement results, press the **"MEMO/READ"** button to store the test results.

Note: When measuring the L-N voltage, the fire (L) and zero (N) wires must be connected.

LOOP Loop measurement

1. Turn the knob to LOOP, refer to the above diagram and connect the test leads.
2. Select the test parameters according to the actual test, press the SET button, then press ▼▲ to select e.g.

- $I\Delta$ (10mA/30mA/100mA/300mA/500mA).
3. Press the "MEASEUE" key to start the test.
 4. The U_c result is displayed. Press the "DISPLAY" key to display RL (loop resistance).
 5. If $U_c > U_{LIMIT}$, an alarm will sound, press any key to switch off the alarm.
 6. If you want to store the measurement results, press the "MEMO" key to store the test results.
 7. When the display  indicates that the fire and zero wires are reversed, no measurement can be made.

RCD (earth leakage switch) measurement

1. Turn the knob to any one of RCDx1/2, RCDx1, RCDx5.
2. Select the test parameters according to the actual, press the SET button, then press $\blacktriangledown \blacktriangle$ to select e.g. $I\Delta$ (10mA/30mA/100mA/300mA/500mA), test current polarity (0° and 180°).
3. Refer to the diagram above and connect the test leads, where L (Fire) and NULL (Zero) and GND (Ground) must be connected.
4. Press the "MEASEUE" button to start the test.
5. The Trip out time is displayed on the main display and the U_c voltage is displayed on the secondary display.
6. If the trip out time is $>300\text{mS}$ (500mS for S models), an alarm will sound, press any key to turn off the alarm.
7. If you want to store the measurement results, press the "MEMO" key to store the test results.
8. When the display  indicates that the fire wire is reversed to the zero wire, no measurement can be made.

Note: When measuring the L-N voltage, the fire wire (L), zero wire (N) and earth wire (E) must be connected.

AUTORAMP triggered current measurement

1. Turn the knob to AUTORAMP .
 2. Select the test parameters according to the actual, press the set button, then press ▼▲ to select e.g. I_{Δ} (10mA/30mA/100mA/300mA/500mA), test current polarity (0° and 180°).
 3. Refer to the diagram above and connect the test leads, where L (Fire) and NULL (Zero) and GND (Ground) must be connected.
 4. Press the "MEASEUE" button to start the test.
 5. The test current and voltage U_c are displayed on the LCD screen.
 6. If the trigger current $> I_{\Delta}$, an alarm will sound, press any key to switch off the alarm.
 7. If you want to store the measurement results, press the "MEMO" key to store the test results.
 8. When the display indicates that the fire wire is reversed to the zero wire, no measurement can be made.
- Note: When measuring the L-N voltage, the fire (L), zero (N) and earth (E) wires must be connected.

Measurement data storage

If you need to store the measurement results, press the "MEMO" button after the measurement is completed to store the results and the measurement data is automatically stored in the mainframe memory.

Reading data

- a) Turn on the instrument, in any position
- b) Press and hold the "MEMO/READ" key, the stored serial number will be displayed on the secondary display and will be flashing .
- c) Press the "▲" or "▼" key to locate the serial number to be read
- d) Press the "ENTER" key to confirm
- e) The stored result is shown on the display
- f) If additional data is to be read, repeat steps c) to e).
- g) If the "MEASURE" key is pressed or the knob is turned during the above operation, the current operation is exited and the test is returned to normal.
- h) When the results are displayed, press the "CLR" key and "CLR" is displayed
- i) When "CLR" is displayed, pressing "ENTER" will delete the current data.
- j) When "CLR" is displayed, pressing any other key will abort the deletion of the current data and the serial number read will automatically be added to 1 and will jump to step c).

Clearing ALL data

- a) Press the "CLR" key
- b) Press the "CLR" key again and "CLR ALL" will be displayed
- c) If the "CLR" key is pressed again, the current operation will be exited and the test will return to the normal test state

- d) Pressing the "ENTER" key will clear all data and return to the normal test state when finished
- e) If the "MEASURE" key is pressed or the knob is turned during the above operation, the current operation will be exited and the test will return to the normal test state.

Input voltage indication

When the AC input voltage exceeds a value of 440V (RMS) during measurement , the meter will display ">440V". When the input voltage exceeds 30V, the " " symbol will be displayed on the LCD to indicate to be careful with safety.

Backlight display

When the backlight button is pressed, the backlight lights for about 30 seconds and then automatically turns off.

Automatic turn-off

1. When the meter is not operated for 10 minutes, it will automatically be turned off.
After the meter is automatically turned off, the knob switch must be turned to the OFF position for 5 seconds before performing the normal operation .
2. press and hold the backlight key to turn it on, the meter will cancel the automatic switch-off function.
Note: When the meter is measuring high voltage, it will not shut down automatically.

Overheat indication

An alarm will appear when the internal overheating occurs and the LCD will display the character "HOT".

Low battery voltage indication

When the meter's battery is under-voltage, the  symbol is displayed at the top right of the display. In this case, the battery needs to be replaced with a new one.

General characteristics

- Conforms to IEC/EN 61010-1 1000V CAT III, 600 V CAT IV safety standards
- Maximum common mode voltage: 600V AC RMS
- Display type: LCD display
- Range selection: Fully automatic range
- Frequency detection: automatic
- Over-range display: ">"
- Power supply: 8 x 1.5V AA batteries
- Power consumption: 100mW
- Storage temperature: -20°C ~ 70°C
- Operating temperature: 0°C to 40°C

- Temperature coefficient: for temperatures below 18 °C or above 28 °C, the coefficient is per (°C) x 0.05 x (specified accuracy)
- 12,000m Storage altitude: 12,000m
- Operating altitude: 2,000m CAT III 600V; 3,000m CAT II 600V
- Dimensions: 200mm x 155mm x 76mm
- Weight: approx. 500g (including battery)

Technical specifications

Items	Range	Accuracy	Resolution
Jump off time	X1 $I_{\Delta N}$ 300ms (slow 500ms) X5 $I_{\Delta N}$ 40ms(slow 150ms)	$\pm 3\text{ms}$	0.1ms
Jump off current	(0.2-1.1) $I_{\Delta N}$	$\pm 0.1 I_{\Delta N}$	0.05 $I_{\Delta N}$
Contact voltage	0-99.9V	$\pm (10\% +0.2V)$	0.01, 0.1V
AC current $U_{L-N} \quad U_{L-L} \quad U_{L-E}$	0-440V	$\pm (3\% +3V)$	1V
Frequency	DC, 45-65Hz	$\pm 1\text{Hz}$	1Hz
Contact voltage U_C	0-19.9V	$\pm (10\% +0.2V)$	0.01V
	10.0V-99.9V		0.1V
Loop resistance (RL)	0.1-2000 Ω	$\pm (10\% +0.2V)$	
R_L Test current	0.5 $I_{\Delta N}$	$\pm (10\% +10d)$	0.05 $I_{\Delta N}$

Test current multiplier	x0.5, x1, x5		
Current Stages ($I_{\Delta N}$)	10,30,100,300,500		
Trigger phase angle	0° or 180°		

RCD Test Current Selection Table

$I_{\Delta N}$ (mA)	$I_{\Delta x1/2}$ (mA)	$I_{\Delta x1}$ (mA)	$I_{\Delta x5}$ (mA)	Auto (mA)
10	5	10	50	
30	15	30	150	
100	50	100	500	
300	150	300	1500	
500	250	500	-----	

Replacing the batteries

WARNING

To avoid electric shock and personal injury, replace the battery when it is under-voltage.

- 1) To replace the battery, turn the meter switch to the OFF position and disconnect the meter test leads from the circuit under test and remove them from the meter.

- 2) Unscrew the fastening screw of the instrument battery cover and remove it
Replace the old battery, noting the orientation of the battery electrodes as marked on the bottom of the battery case.
- 3) Close the battery cover and tighten the screw

①: Screws

②: Battery

